

Features

- Low On resistance.
- 4.5V/-4.5V drive.
- RoHS compliant.

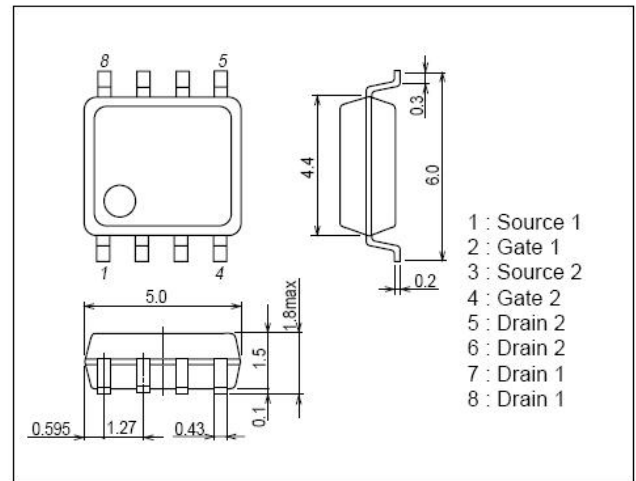

Package Dimensions

 unit : mm
 SOP-8

Specifications

Absolute Maximum Ratings at $T_a=25^{\circ}\text{C}$

Parameter	Symbol	Conditions	Ratings		Unit
			N-Ch	P-Ch	
Drain-to-Source Voltage	V_{DSS}		100	-100	V
Gate-to-Source Voltage	V_{GSS}		± 20	± 20	V
Drain Current (DC)	I_D		6	-6	A
Drain Current (Pulse)	I_{DP}	$PW \leq 10\mu\text{s}$, duty cycle $\leq 1\%$	8	-8	A
Allowable Power Dissipation	P_D	Mounted on a ceramic board (1000mm ² ×0.8mm) 1unit	1.3		W
Total Dissipation	P_T	Mounted on a ceramic board (1000mm ² ×0.8mm)	1.7		W
Channel Temperature	T_{ch}		150		$^{\circ}\text{C}$
Storage Temperature	T_{stg}		-55~+150		$^{\circ}\text{C}$

Electrical Characteristics at $T_a=25^{\circ}\text{C}$

Parameter	Symbol	Conditions	Ratings			Unit	
			min	typ	max		
Drain-to-Source Breakdown Voltage	$V_{(BR)DSS}$	$I_D=250\mu\text{A}$, $V_{GS}=0\text{V}$	N-Ch	100	-	-	V
		$I_D=-250\mu\text{A}$, $V_{GS}=0\text{V}$	P-Ch	-100	-	-	
Zero-Gate Voltage Drain Current	I_{DSS}	$V_{DS}=80\text{V}$, $V_{GS}=0\text{V}$	N-Ch	-	-	1	μA
		$V_{DS}=-80\text{V}$, $V_{GS}=0\text{V}$	P-Ch	-	-	-1	
Gate-to-Source Leakage Current	I_{GSS}	$V_{GS}=\pm 16\text{V}$, $V_{DS}=0\text{V}$	N-Ch	-	-	± 10	nA
		$V_{GS}=\pm 16\text{V}$, $V_{DS}=0\text{V}$	P-Ch	-	-	± 10	
Gate Threshold Voltage	$V_{GS(th)}$	$V_{DS}=V_{GS}$, $I_D=250\mu\text{A}$	N-Ch	1.2	1.8	2.6	V
		$V_{DS}=V_{GS}$, $I_D=-250\mu\text{A}$	P-Ch	-1.2	-1.8	-2.6	
Static Drain-to-Source On-State Resistance	$R_{DS(ON)}$	$I_D=3\text{A}$, $V_{GS}=10\text{V}$	N-Ch	-	150	220	$\text{m}\Omega$
		$I_D=-3\text{A}$, $V_{GS}=-10\text{V}$	P-Ch	-	155	225	

Electrical Characteristics at $T_a=25^{\circ}\text{C}$ (Continued)

Parameter	Symbol	Conditions	Ratings			Unit	
			min	Typ	max		
Static Drain-to-Source On-State Resistance	$R_{DS(ON)}$	$I_D=3\text{A}, V_{GS}=4.5\text{V}$	N-Ch	-	200	310	m Ω
		$I_D=-3\text{A}, V_{GS}=-4.5\text{V}$	P-Ch	-	210	315	
Input Capacitance	C_{iss}	$V_{DS}=30\text{V}, V_{GS}=0\text{V}, f=1\text{MHz}$	N-Ch	-	470	-	pF
		$V_{DS}=-30\text{V}, V_{GS}=0\text{V}, f=1\text{MHz}$	P-Ch	-	1050	-	
Output Capacitance	C_{oss}	$V_{DS}=30\text{V}, V_{GS}=0\text{V}, f=1\text{MHz}$	N-Ch	-	40	-	pF
		$V_{DS}=-30\text{V}, V_{GS}=0\text{V}, f=1\text{MHz}$	P-Ch	-	70	-	
Reverse Transfer Capacitance	C_{rss}	$V_{DS}=30\text{V}, V_{GS}=0\text{V}, f=1\text{MHz}$	N-Ch	-	25	-	pF
		$V_{DS}=-30\text{V}, V_{GS}=0\text{V}, f=1\text{MHz}$	P-Ch	-	40	-	
Turn-on Delay Time	$t_{d(on)}$	N-Channel $V_{GEN}=10\text{V}, V_{DS}=30\text{V},$ $R_L=30\Omega, I_D=1\text{A}, R_{GEN}=6\Omega$	N-Ch	-	6	12	nS
Rise Time	t_r		P-Ch	-	9	17	
Turn-off Delay Time	$t_{d(off)}$	P-Channel $V_{GEN}=-10\text{V}, V_{DS}=-30\text{V},$ $R_L=30\Omega, I_D=-1\text{A}, R_{GEN}=6\Omega$	N-Ch	-	25	46	nS
Fall Time	t_f		P-Ch	-	81	147	
Total Gate Charge	Q_g	N-Channel $V_{DS}=50\text{V}, V_{GS}=10\text{V}, I_D=2\text{A}$	N-Ch	-	12	17	nC
Gate-to-Source Charge	Q_{gs}		P-Ch	-	21.3	30	
Gate-to-Drain "Miller" Charge	Q_{gd}	P-Channel $V_{DS}=-50\text{V}, V_{GS}=-10\text{V}, I_D=-2\text{A}$	N-Ch	-	1.8	-	nC
Diode Forward Voltage	V_{SD}		P-Ch	-	3.2	-	
Diode Forward Voltage	V_{SD}	$I_S=2.5\text{A}, V_{GS}=0\text{V}$	N-Ch	-	0.75	1.3	V
		$I_S=-2.5\text{A}, V_{GS}=0\text{V}$	P-Ch	-	-0.75	-1.3	

Pin Description

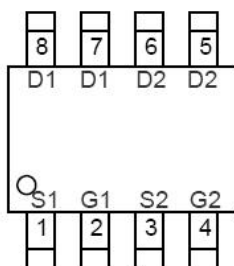

TOP VIEW
SOP-8

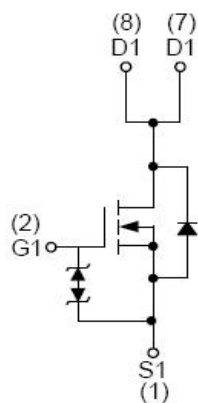

N-Channel

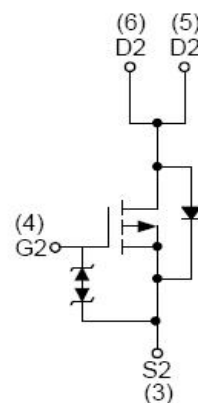

P-Channel

Typical Characteristics at $T_a=25^{\circ}\text{C}$

N-Channel

Output Characteristics

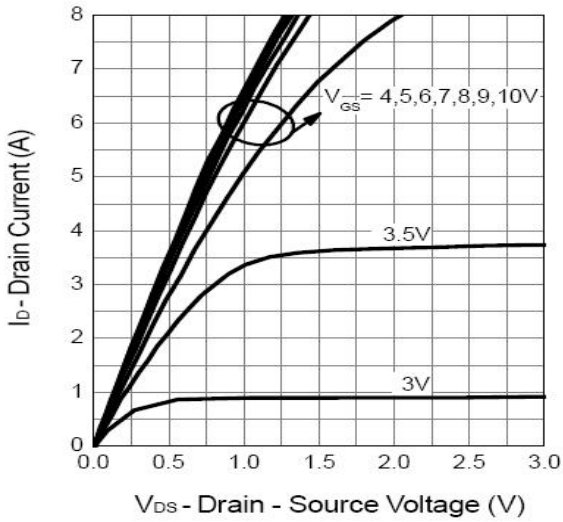

Drain-Source On Resistance

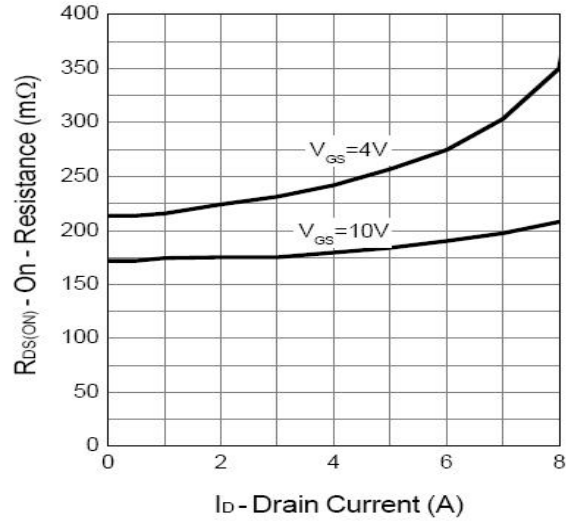

Gate-Source On Resistance

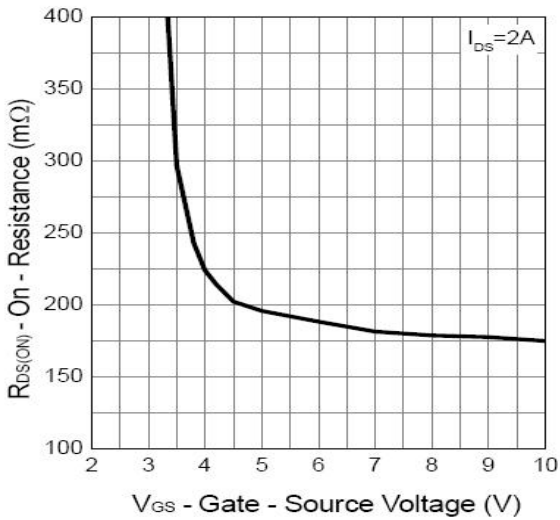

Gate Threshold Voltage

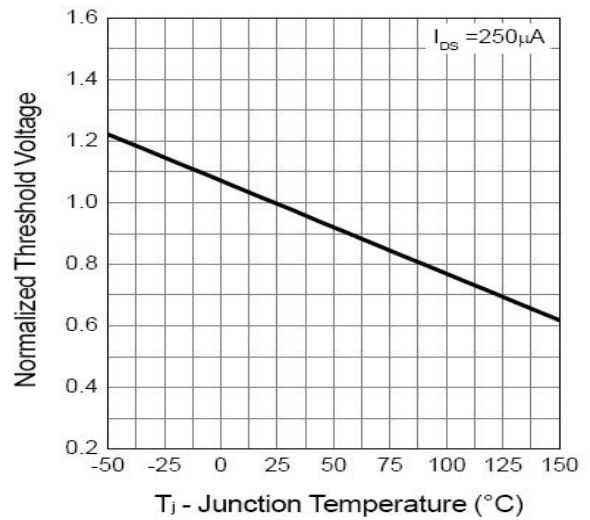

Drain-Source On Resistance

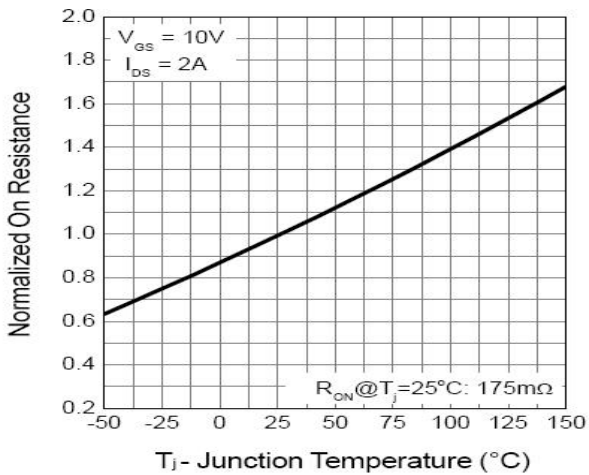

Source-Drain Diode Forward

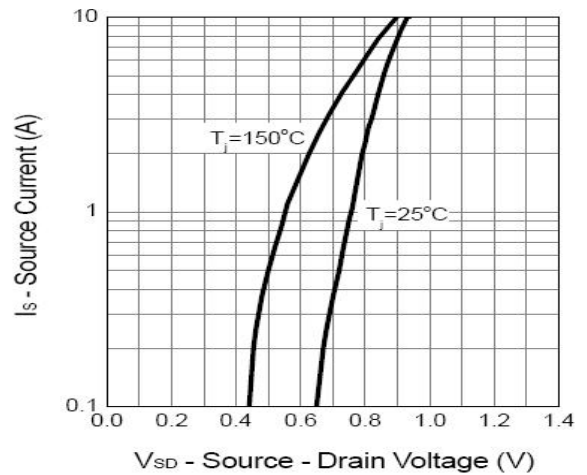

Typical Characteristics at $T_a=25^{\circ}\text{C}$

N-Channel

Capacitance

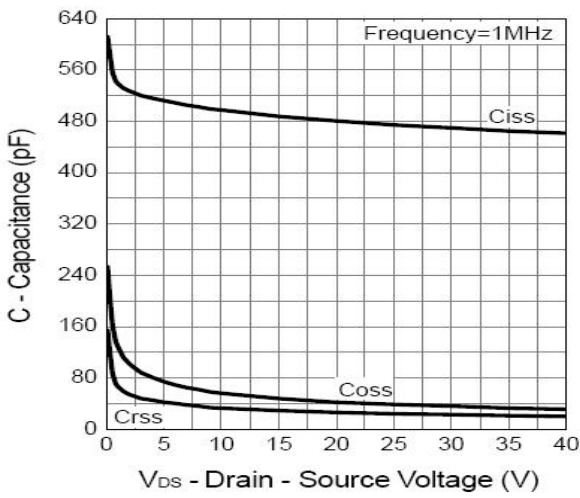

Gate Charge

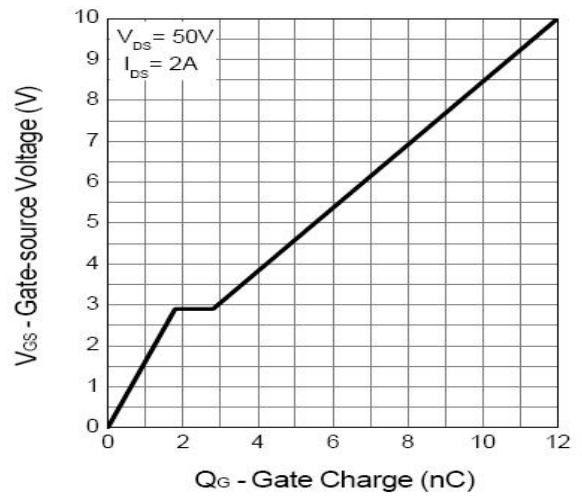

Power Dissipation

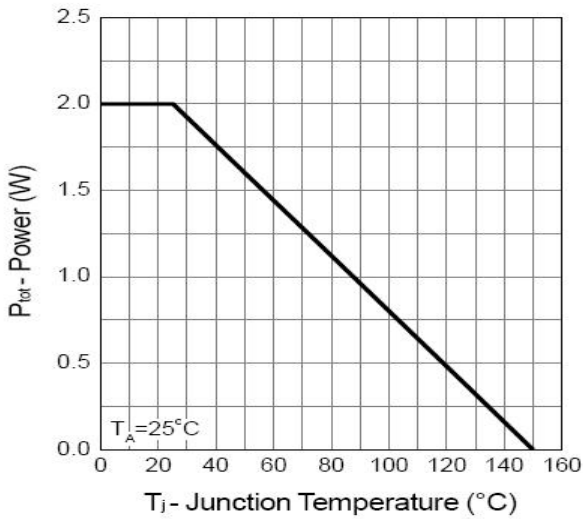

Drain Current

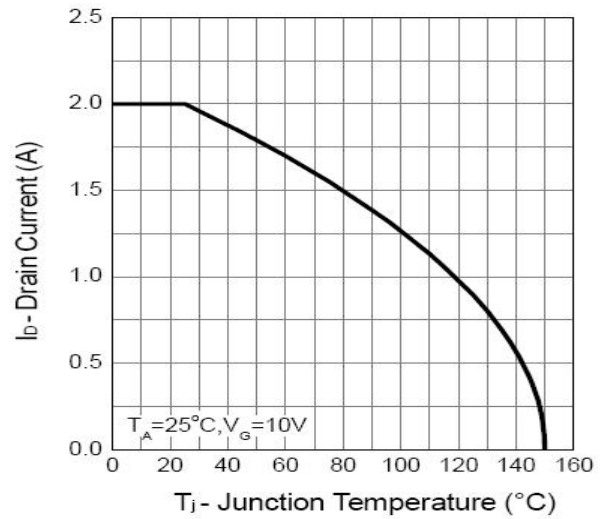

Safe Operation Area

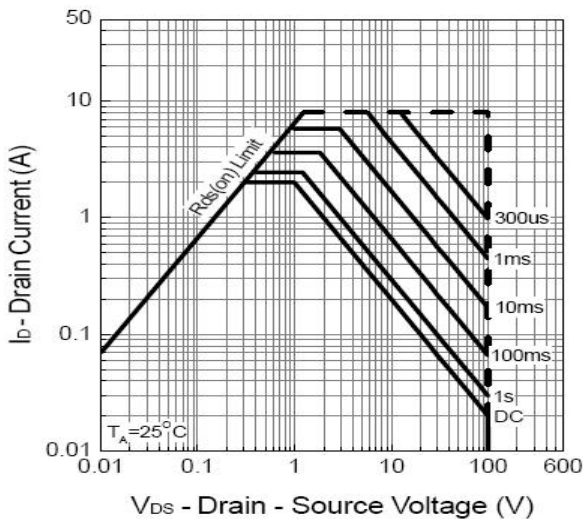

Thermal Transient Impedance

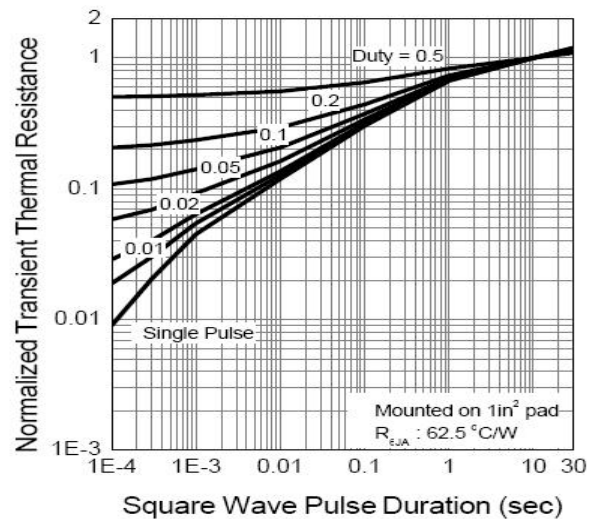

Typical Characteristics at $T_a=25^{\circ}\text{C}$

P-Channel

Output Characteristics

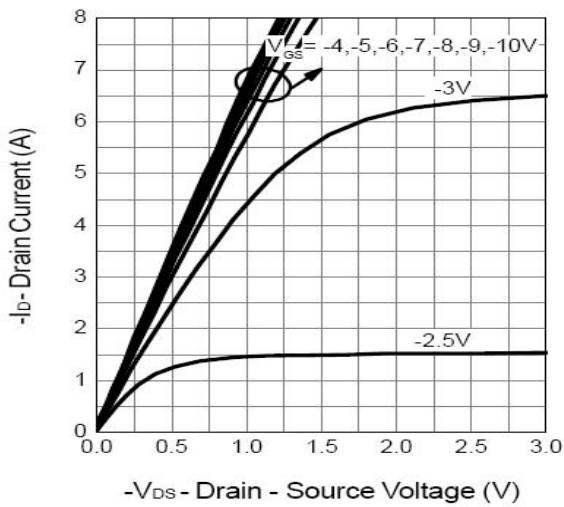

Drain-Source On Resistance

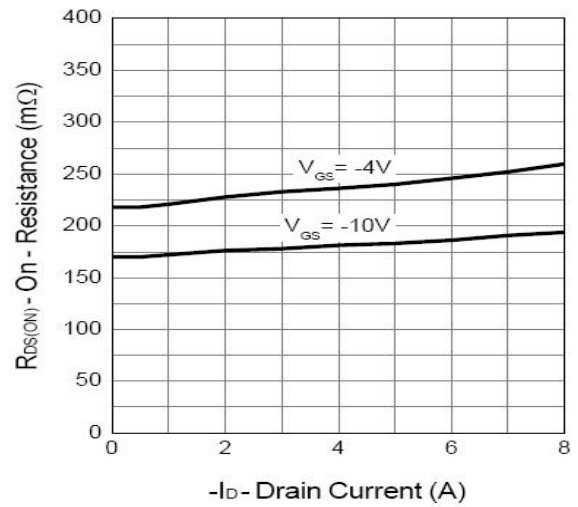

Gate-Source On Resistance

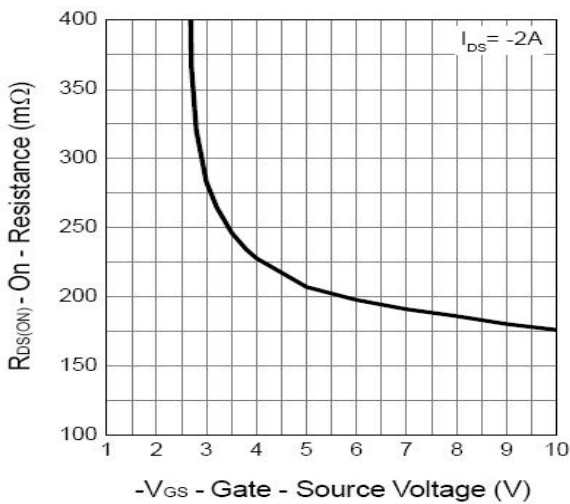

Gate Threshold Voltage

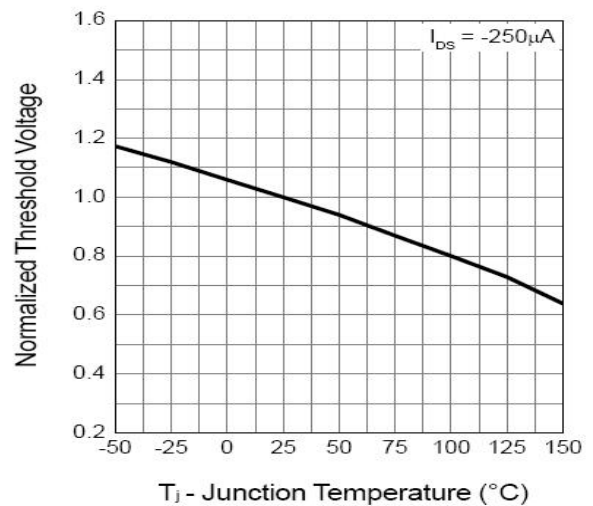

Drain-Source On Resistance

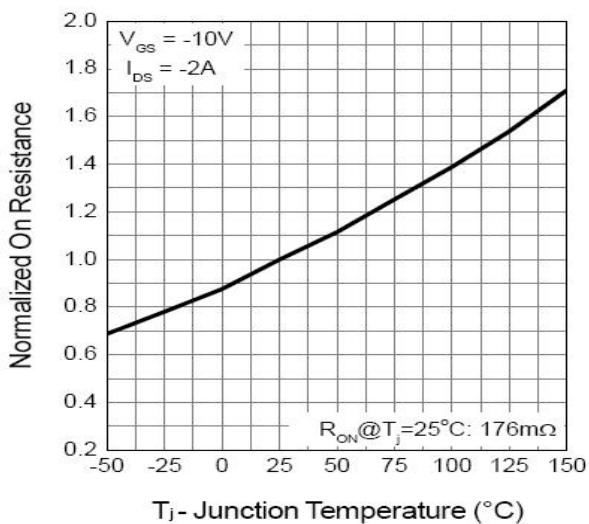

Source-Drain Diode Forward

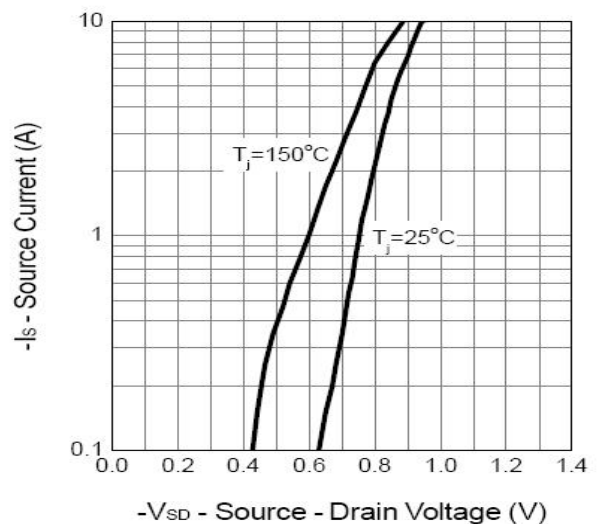

Typical Characteristics at $T_a=25^{\circ}\text{C}$

P-Channel

Capacitance

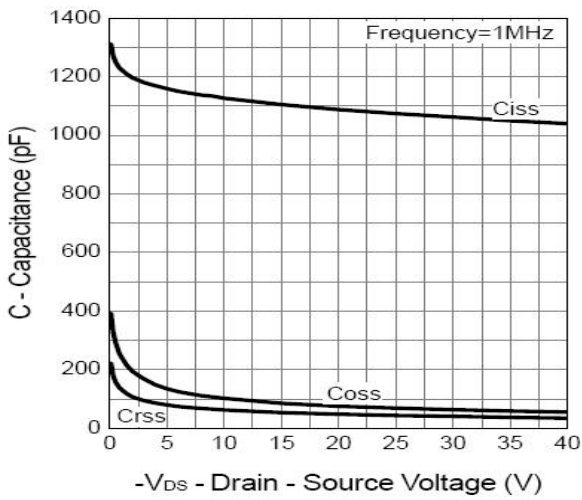

Gate Charge

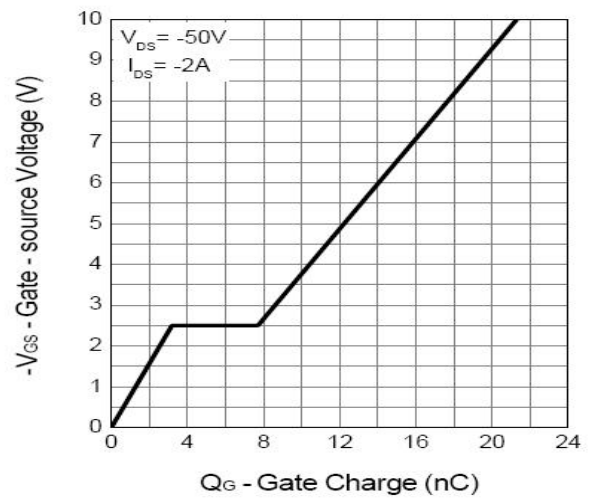

Power Dissipation

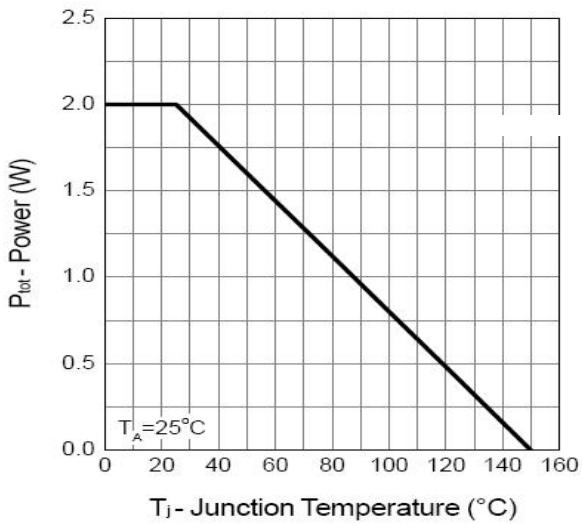

Drain Current

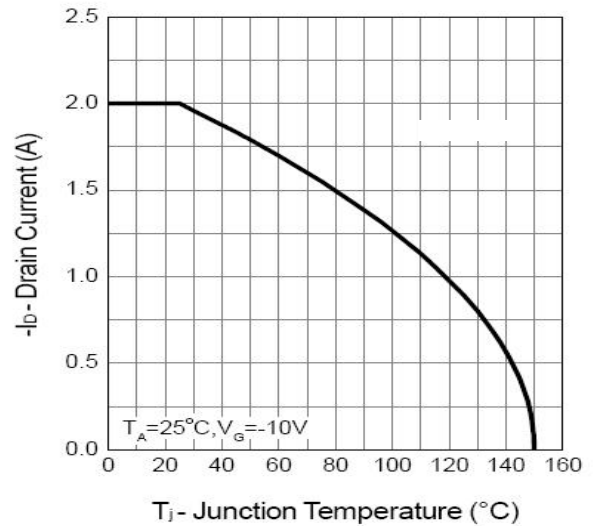

Safe Operation Area

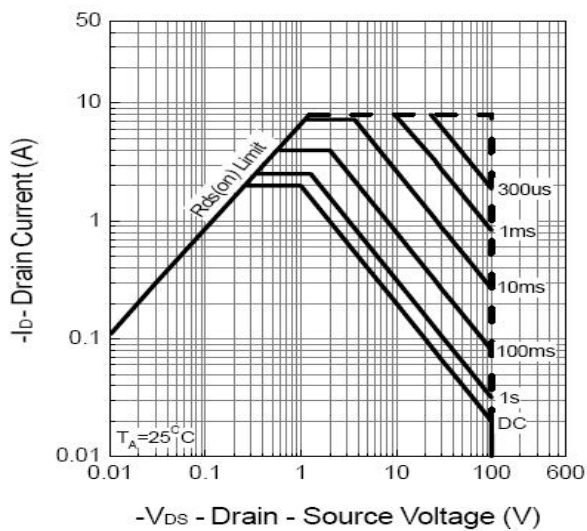

Thermal Transient Impedance

